

idealheating.com

HALO
AIR

Halo Air RF & Wi-Fi 2-Zone Installation Guide

For use with



HALO AIR RF & WI-FI

UIN: 234791 (RF), 234792 (Wi-Fi)

Comprising of 234821 (Halo Air Thermostats) & 234825 (Halo Air interface) and 235327 (Halo Air bracket).

Internet connected* wireless Programmable Room Thermostat (PRT).

Compatible with the following heat pumps : Logic Air.



The Ideal Halo Air is a wireless PRT that is paired with the Halo Smart Interface installed alongside the Heat Pump. The Smart Interface is fitted into the Smart Interface Bracket and is wired directly to the Heat Pump and communicates to the PRT via BSB.

Each Halo unit is powered by 4 AA batteries. Communication from the Smart Interface to the PRT is through Zigbee, a local RF protocol.

The Smart Interface is Wi-Fi enabled and can be linked to the home Wi-Fi network to allow app-controlled heating through the Halo app*.

The Halo Air PRT's including the Smart Interface bracket, must be installed by a competent person with the appropriate safety qualifications. Please read the instructions carefully.

 **WARNING: Read the instructions carefully. Failure to follow these instructions can damage the product or cause a hazardous condition.**

These instructions are applicable to the Ideal Heat Pump models stated and must not be used with any other make or model of Heat Pump. This product must be installed to all applicable standards.

These instructions are written specifically for installation of this product with an Ideal Heating Logic Air Heat pump.

Should you wish to install this device to a Logic Boiler, accessory No 235797 will also be required. For instructions, please refer to the Logic Air installation manual, found at idealheating.com.

 **WARNING: Always isolate the mains supply before installing or working on any components that require a 230 Vac supply.**

GETTING STARTED

The Ideal Halo app is available to download from the Apple app store and on Google Play. To save time the householder may want to download the app and set up the account whilst the thermostat is being installed.



*Wi-Fi version only. To upgrade RF to internet compatible please contact Ideal Heating: 01482 498660

A. KIT CONTENTS



1. Halo PRT display unit x2



2. PRT rear housing x2

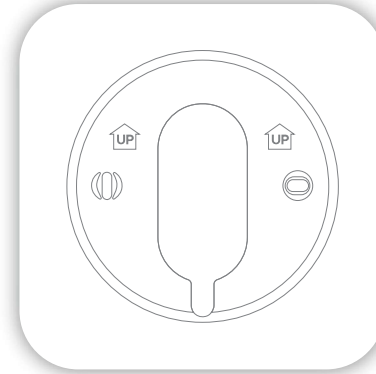

3. Trim plate x2

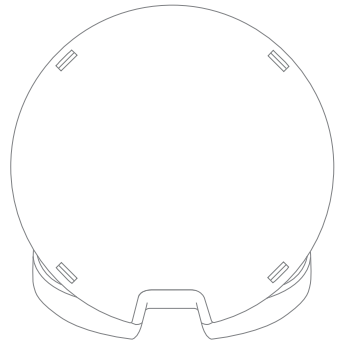

4. Desk stand x2

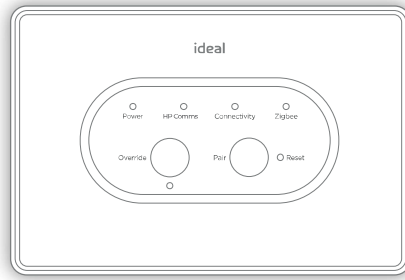

5. Smart Interface

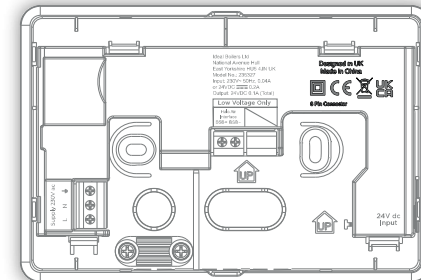

6. Smart Interface bracket



7. Install and user guides

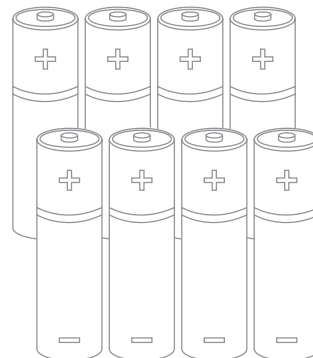

8. AA Batteries x 8

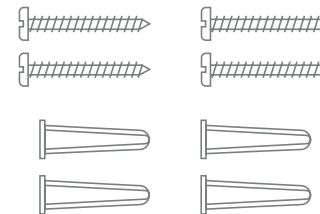

9. Screws x4 & Rawlplugs™ x4

B. LOCATION GUIDELINES

The Halo Air uses wireless Zigbee communication between the control PRT and the Interface, up to a maximum range of 30 metres. Occasionally house construction and materials can reduce this communication range and it is advisable, where possible, to try and avoid directing communication through metal frames or solid concrete walls.

If the distance between the Halo Air Interface and either PRT is above 30 metres or the install location is challenging, consider using the Ideal Zigbee Booster (Product Code: 221132) or mounting the Interface bracket further away from the Heat Pump.

Further details on this at idealheating.com

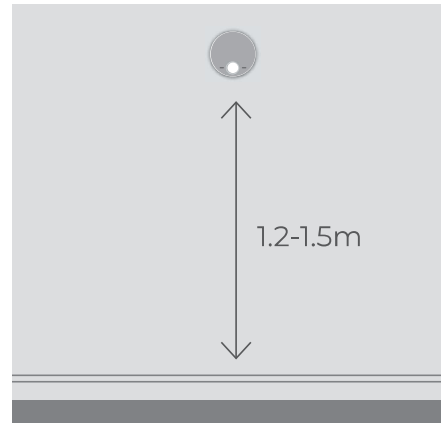

1. Mounted 1.2-1.5m above the floor

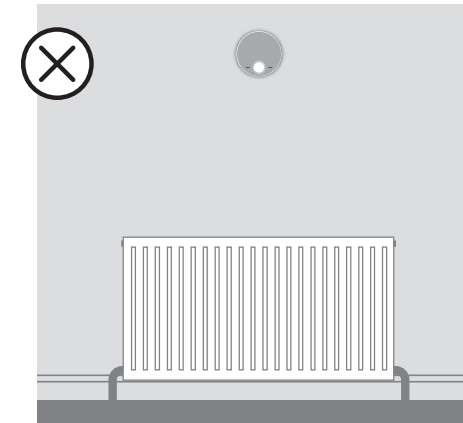

2. Not above a radiator/heat source

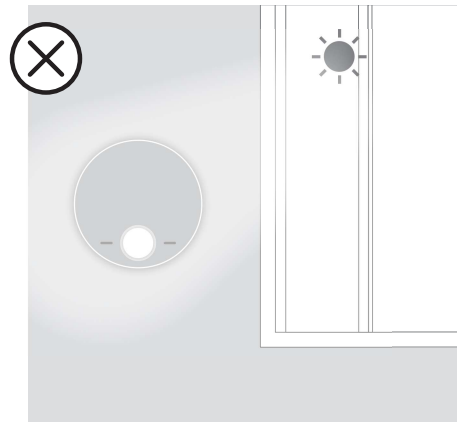

3. Not in direct sunlight



4. Away from any drafts

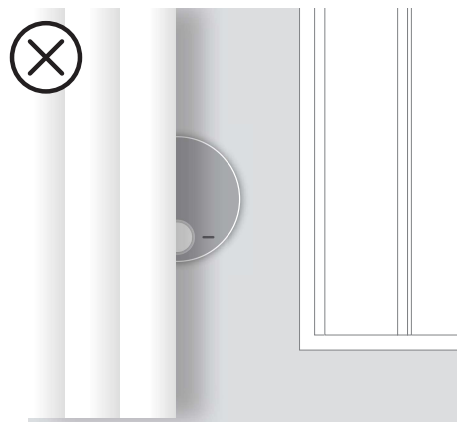

5. Not fitted behind curtains

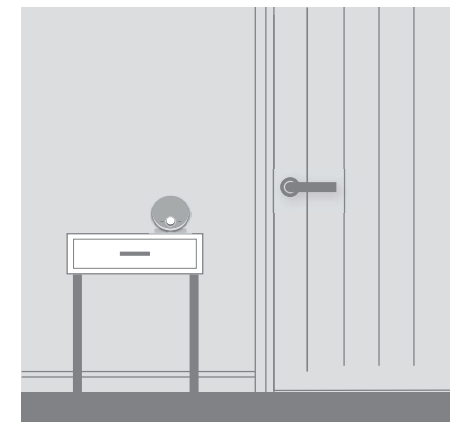

6. Internal use only

C. INSTALLING THE HALO PRT'S

The Halo PRT's can be either wall mounted or desk mounted.

WALL MOUNTING THE HALO

If there are any concerns regarding signal strength and location of the wall mounted PRT it is advisable to pair the control and check the signal strength before fixing to the wall.

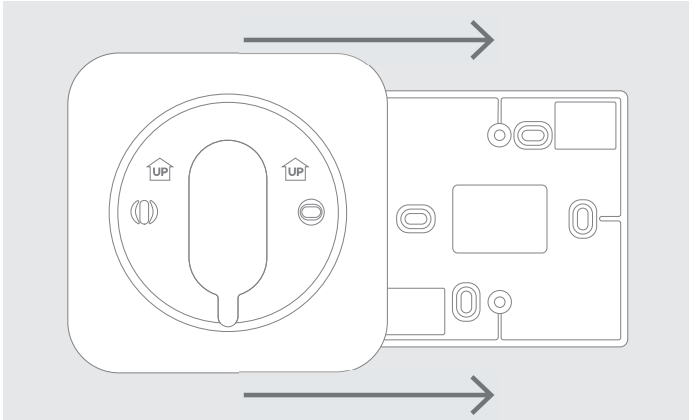

1. The Halo can be installed with or without the provided trim plate.

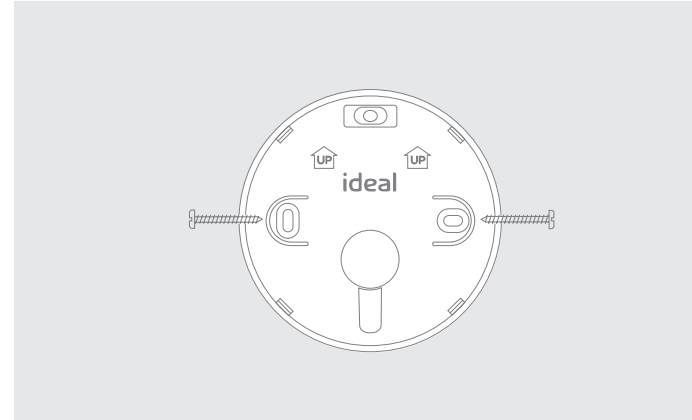

2. If no trim plate is required, use the rear housing of the Halo to position the unit on the wall, alternatively secure rear housing to trim plate. Take care not to over-tighten the screws.

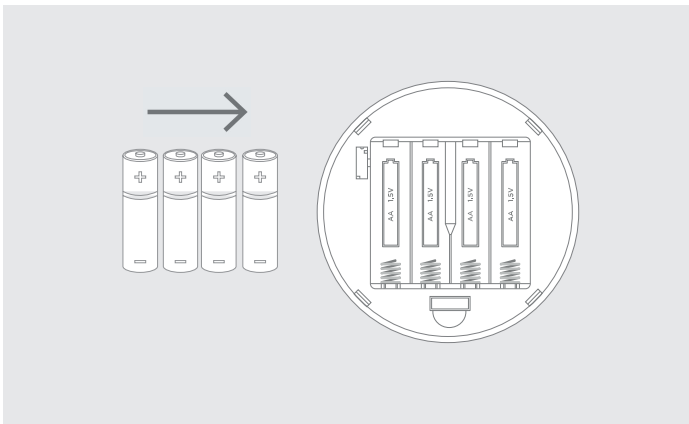

3. Insert the 4 AA batteries provided into the front housing of the Halo. Pay close attention that the orientation of the batteries is as indicated in the housing.

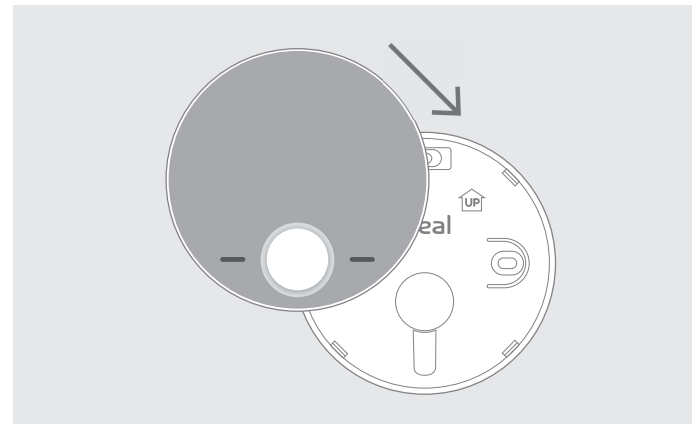

4. Locate the front housing (display) in position perpendicular to the rear housing and clip into place.

C. INSTALLING THE HALO PRT'S (CON'T)

DESK MOUNTING THE HALO

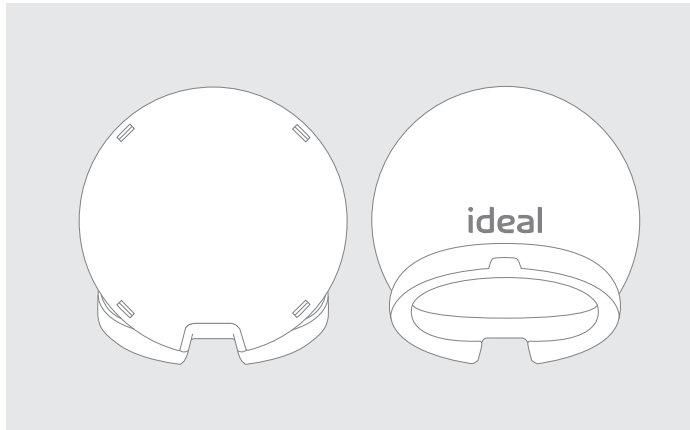

1. The Halo has an integrated rear housing and desk stand.

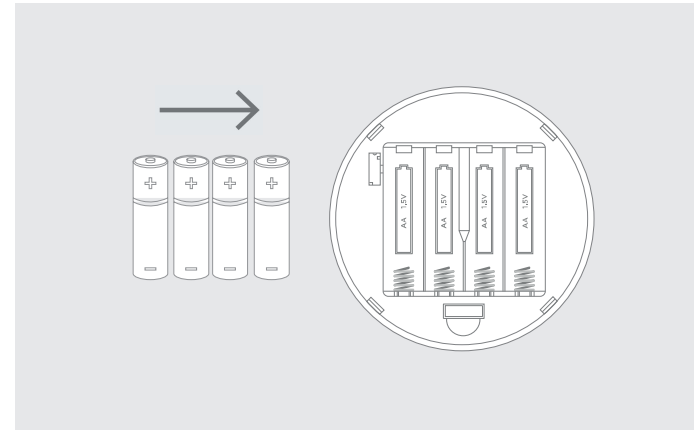

2. Insert the 4 AA batteries provided into the front housing of the Halo. Pay close attention that the orientation of the batteries is as indicated in the housing.

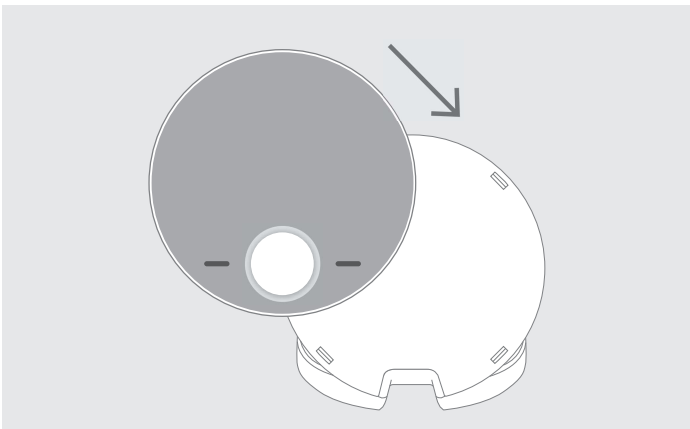

3. Clip the combined rear housing and desk stand into place.

Note: The Halo PRT can also be powered by a micro USB. The micro USB port is within the battery compartment. Both the desk stand and wall plate are designed to allow the micro USB cable to exit the PRT unhindered.

D. INSTALLATION OF THE SMART INTERFACE

To install the Smart Interface into a new heat pump follow the steps below.

The Smart Interface Bracket can be mounted straight to the wall or onto an existing single gang wall box.

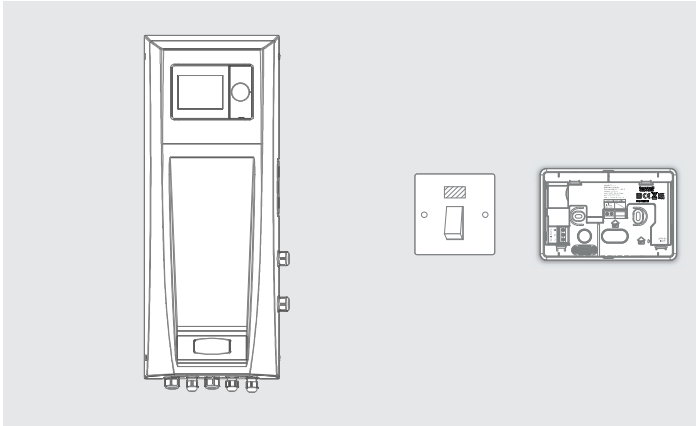

1. Locate the bracket in a suitable location close to the heat pump control box and a fuse spur as the bracket is hard wired to both.

Note: The bracket should be <30m from the Wi-Fi router otherwise a Wi-Fi extender may need to be used.

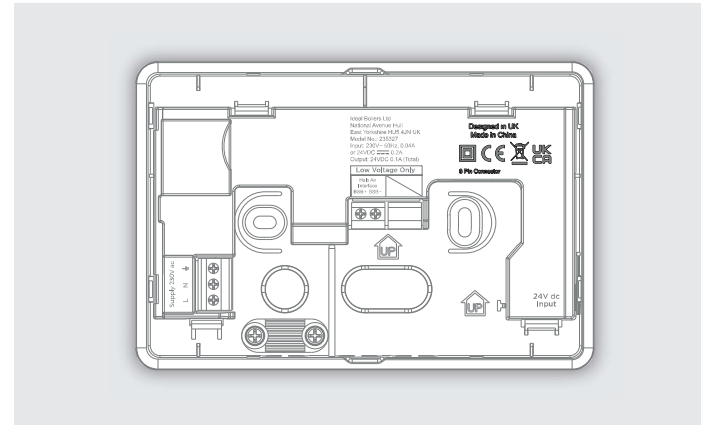

- 2a. To mount directly onto the wall, mark and drill 2 mounting holes and fix the bracket to the wall using suitable fixings for the wall type.

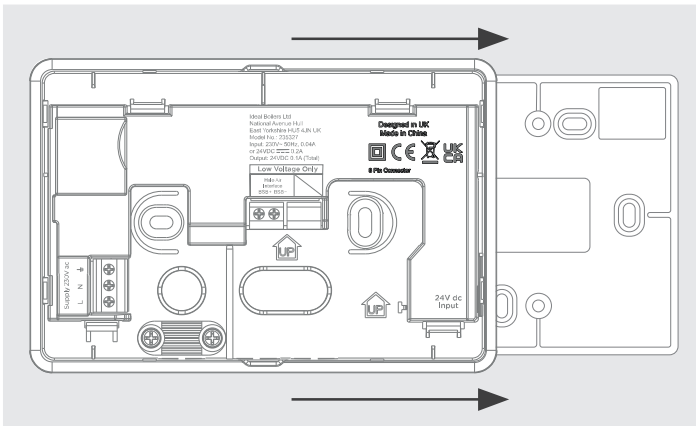

- 2b. To mount over the electrical box, place the bracket over the electrical box and fix into place.

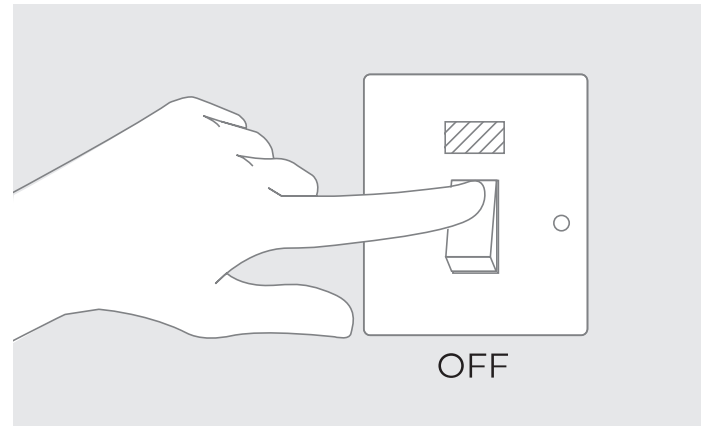

3. Isolate the mains supply to both heat pump control box and fuse spur for the bracket.

D. INSTALLATION OF THE SMART INTERFACE (CONT.)

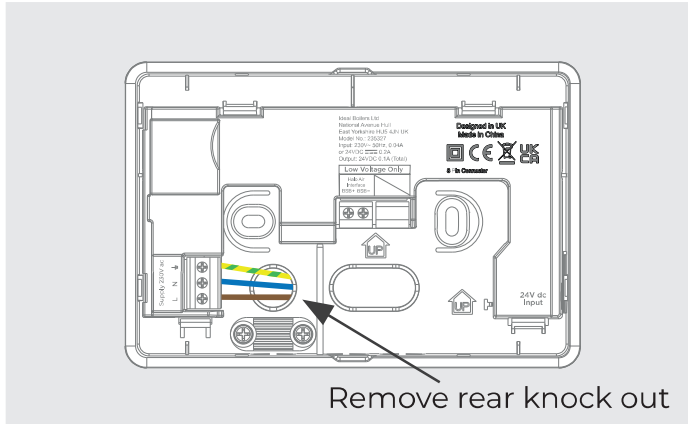

4a. Rear cable mounting; From the fuse spur wire the Live, Neutral and Earth connections into the left hand side connections in the Smart Interface Bracket marked L, N, (E).

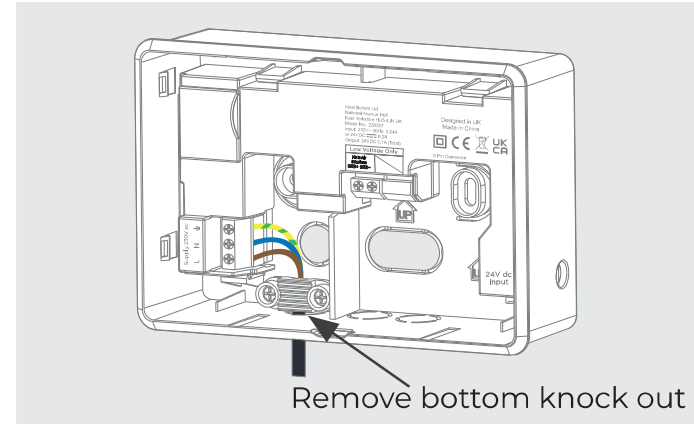

4b. Surface cable mounting; From the fuse spur wire the Live, Neutral and Earth into the left hand side connections in the Smart Interface Bracket marked L, N, (E). Using the cable clamp provided.



5. Wire the low voltage connection into the BSB terminals located in the central position. Rear or surface mount options are available.

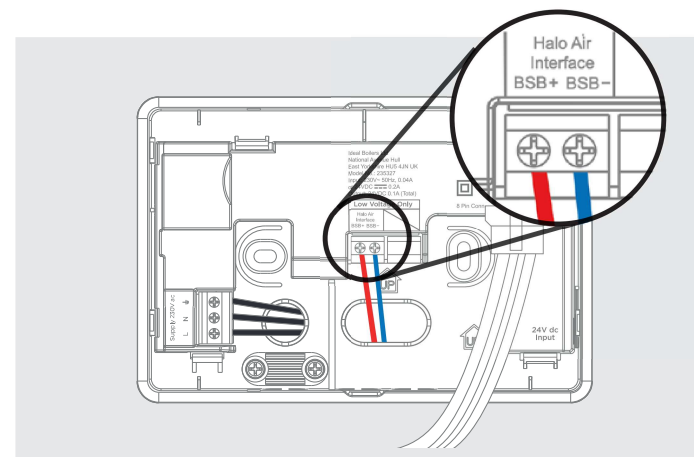

5a. BSB is polarity conscious. Ensure that + and - connections are wired to the same terminal in the heat pump, + to + and - to -.

D. INSTALLATION OF THE SMART INTERFACE (CONT.)

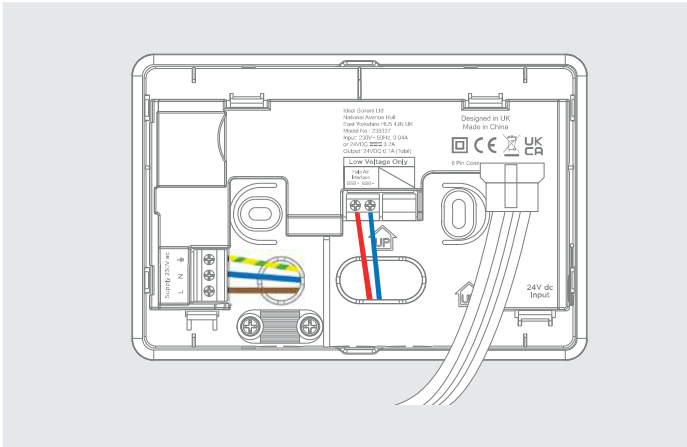

6. Install the Smart Interface by connecting the plug on the Smart Interface to the connector in the bracket.

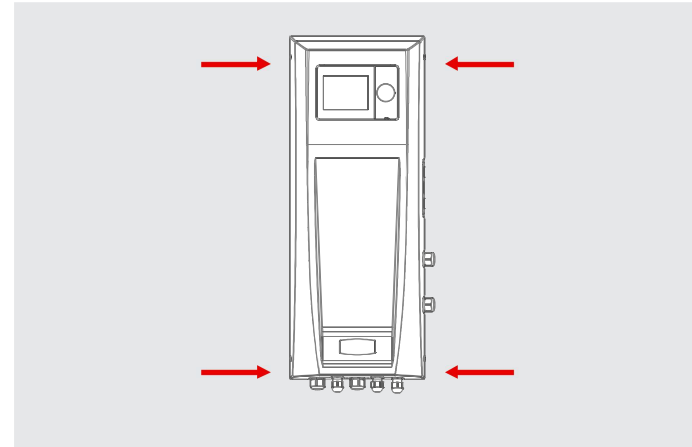

7. Ensuring Mains supply is still isolated, remove the 4 screws retaining the control box cover before removing the cover.

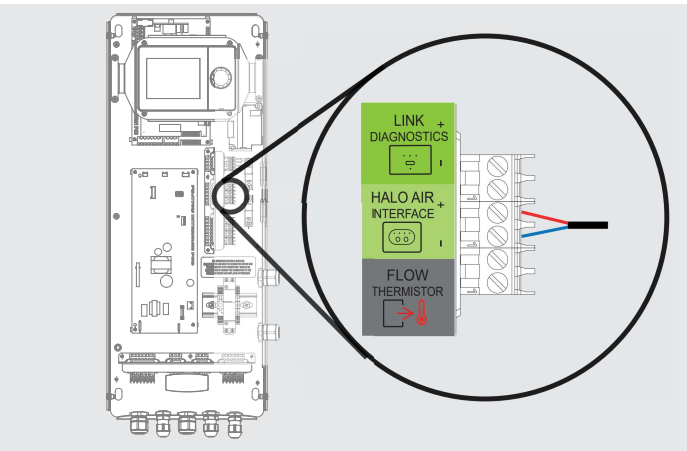

8. Wire the BSB connection from the bracket into the Halo Air Interface terminals making sure the polarity is correct, and cable retention is in place

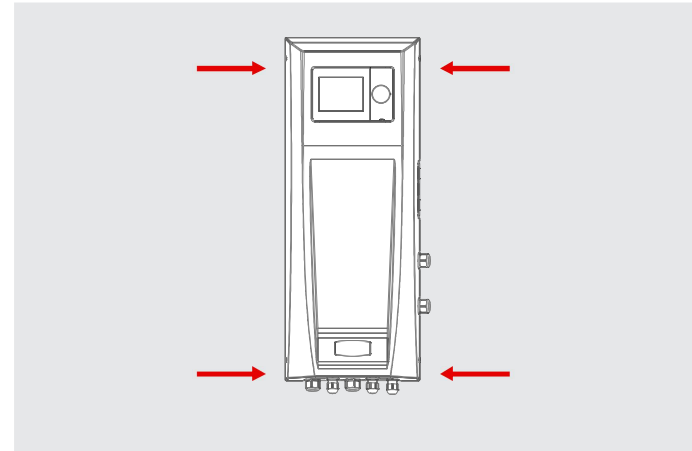

9. Install the cover and screws.

E. LOGIC AIR AND HALO SET-UP

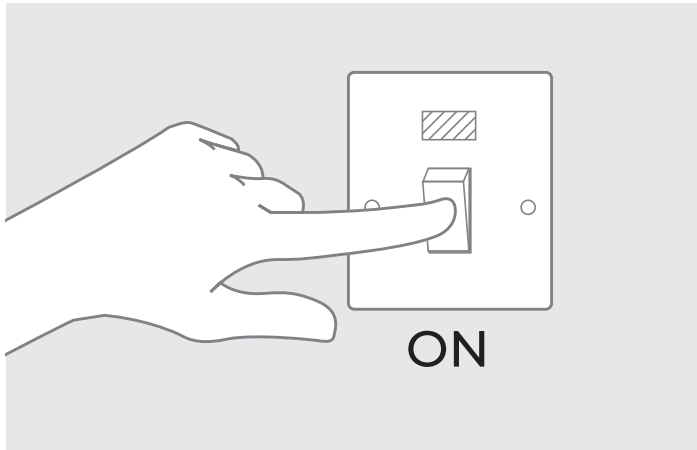

1. Re-establish power to both heat pump and smart interface bracket. The Halo Smart Interface will power up and begin setup, this can take up to 90 seconds.

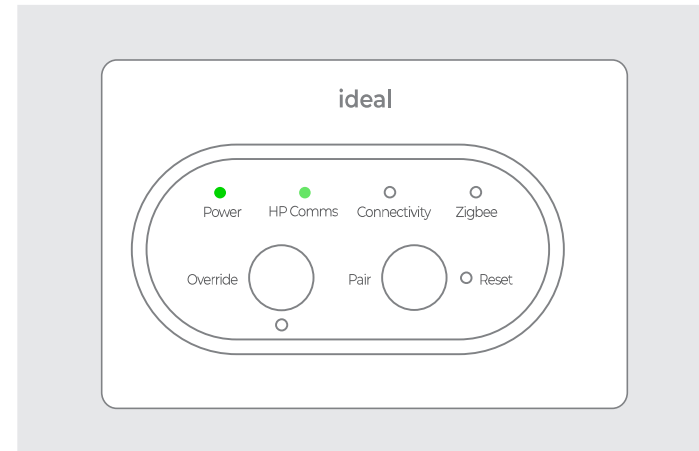

2. Once setup is complete the green Power LED and HP Comms LED should be solid **GREEN** and the only LEDs illuminated. If the HP Comms is not illuminated check the BSB wiring and polarity.

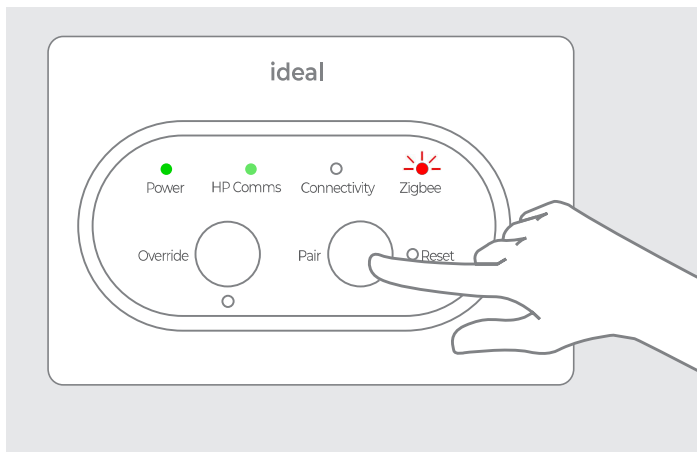

3. Press and hold the Pair button on the Smart Interface until the Zigbee LED starts flashing **RED** to begin the pairing process with the Halo PRT's.



4. Continue the pairing sequence on the zone 1 Halo PRT

F. PAIRING OF THE HALO PRT

ZONE 1

The Halo PRT controlling zone 1 will now need to be paired with the Smart Interface installed by the Heat Pump. Ensure the Smart Interface is still in pairing mode with the Zigbee LED flashing red.

1. When the batteries are inserted, the Halo PRT will power up automatically.
2. The device will prompt pairing with the Smart Interface using an easy step-by-step process.
3. Simply follow the on-screen guide to select the system type, **Multi Zone**, and the zone the PRT will cover, **Zone 1**.
4. The Halo PRT screen will show “Pairing in Progress”, then “Synchronisation in Progress” and then “Pairing Complete” when the Halo PRT has successfully connected to the Smart Interface.
5. The device will automatically prompt set up of the time and date.
6. There is the opportunity to add an installer contact phone number into the device at this stage, if not changed this will default to the Ideal Heating Customer Service number.
7. The home screen will be displayed showing the current and target temperature and the temperature bar. The Zigbee communication icon will also be visible on the display.

ZONE 2

The Halo PRT controlling zone 2 will now need to be paired with the Smart Interface installed by the Heat Pump. Ensure the Smart Interface is still in pairing mode with the Zigbee LED flashing red.

1. When the batteries are inserted, the Halo PRT will power up automatically.
2. The device will prompt pairing with the Smart Interface using an easy step-by-step process.
3. Simply follow the on-screen guide to select the system type, **Multi Zone**, and the zone the PRT will cover, **Zone 2**.
4. The Halo PRT screen will show “Pairing in Progress”, then “Synchronisation in Progress” and then “Pairing Complete” when the Halo PRT has successfully connected to the Smart Interface. The Date and Time are automatically uploaded from Zone 1.
5. The home screen will be displayed showing the current and target temperature, and the temperature bar. The Zigbee communication icon will also be visible on the display.

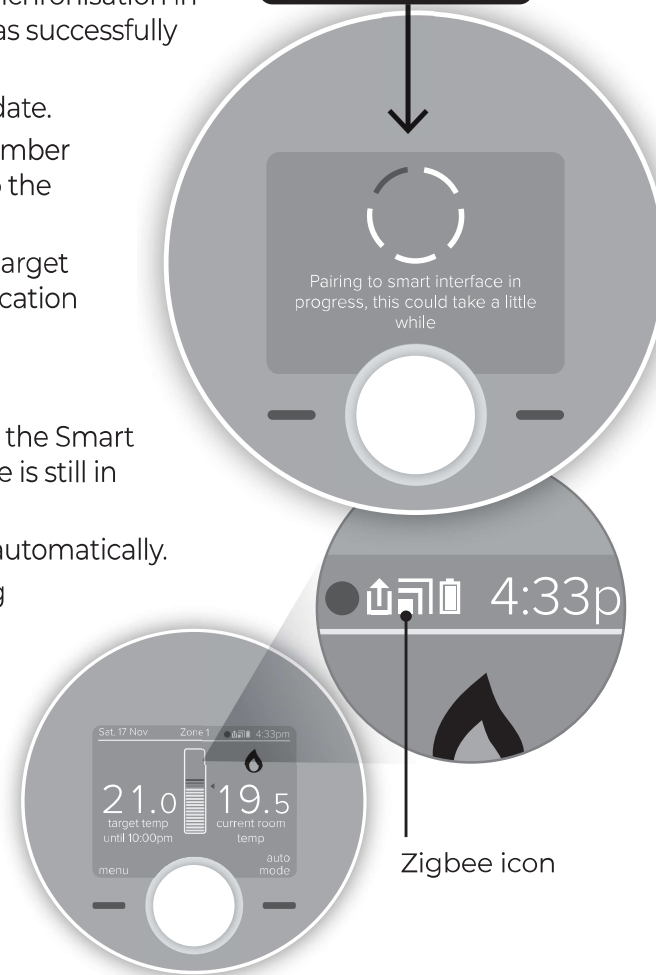
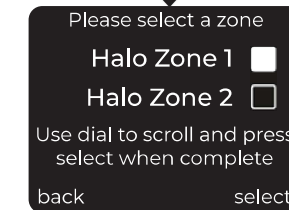
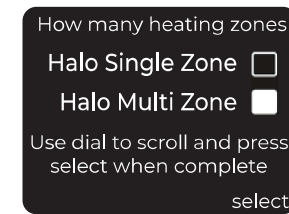

G. ESTABLISHING COMMUNICATION

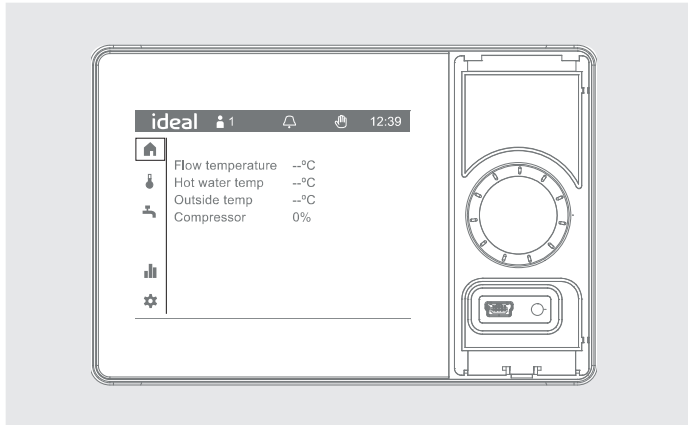

1. Make sure that the Heat Pump is set up and on the home screen.

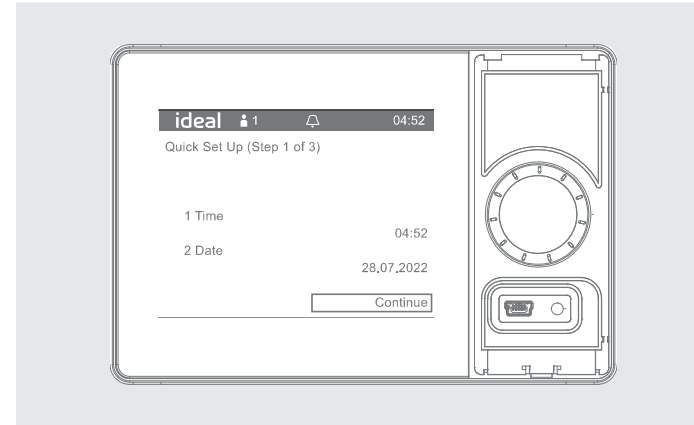

- 1a. If the Heat Pump has not been set up complete the set-up wizard.

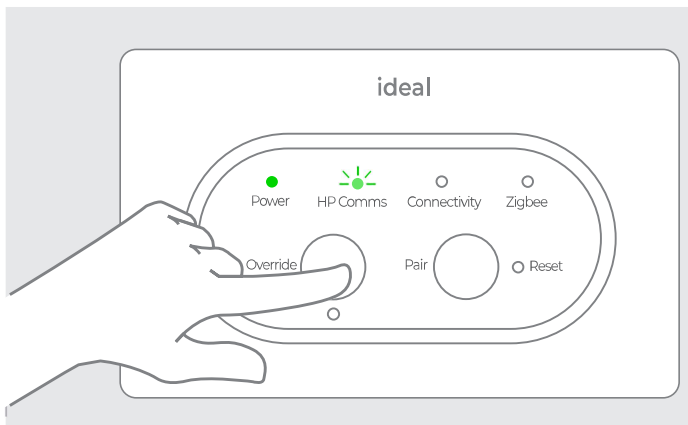

2. To initialize communication between the Heat Pump and Smart Interface press the Override button. The HP Comms LED will flash **GREEN** for up to 1 minute during which time the Halo PRT will display a CF05 information screen.

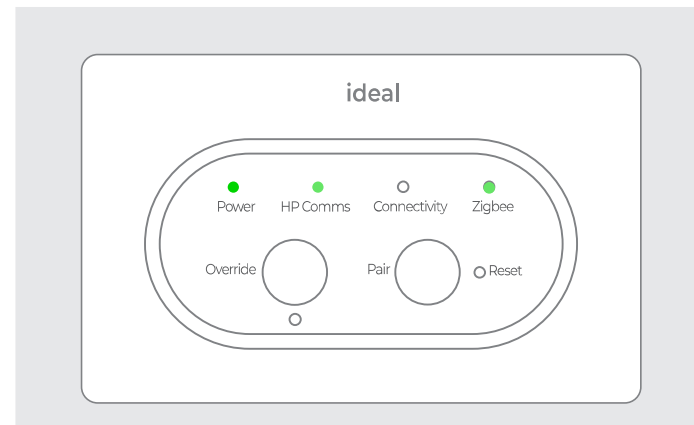

3. Once communication has been established the HP Comms LED will be solid **GREEN** and the Halo PRT will show the home screen.

H. CONNECTING THE HALO TO THE INTERNET*

1. Check the home router is connected to the internet.
2. Ensure 2.4GHz is enabled on the home Wi-Fi router.
3. If it has not been done already, download and install the Ideal Halo app onto the householders phone. (Available on Google Play or the Apple App Store.)
4. Open the Ideal Halo app, tap on create an account and follow the in-app instructions.
5. Once an account has been set up the app will automatically guide the user through connection of the Halo. This will involve using the app to link the Halo Smart Interface to the home Wi-Fi network by following the instructions on the screen.
6. The householder will need the name of their home Wi-Fi network and the password or network key to complete the setup.

Minimum operating requirements

Smart phone/Tablet - iOS 9 Android 6.0

PC latest version of Chrome, Safari, Firefox or Internet Explorer on Mac OS or Windows 7

*Wi-Fi version only. To pay to upgrade the RF version please contact Ideal Heating Customer Service: 01482 498660.

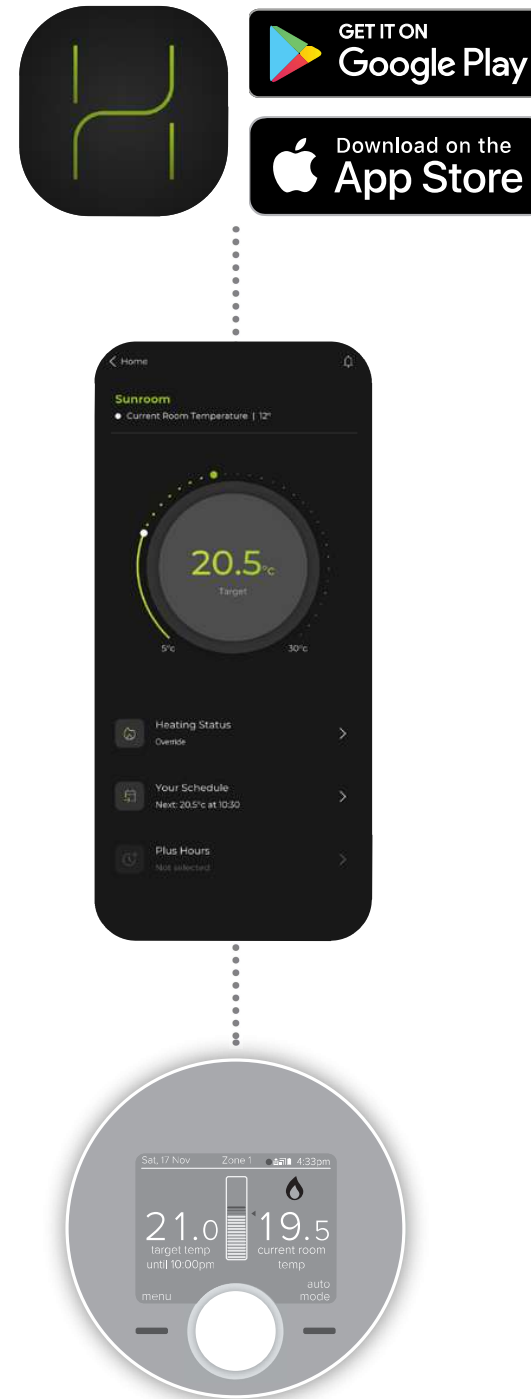

I. HALO FEATURES AND CONFIGURATION

To enter the settings menu press the menu button.

Menu options	Action
Holiday	Holiday mode allows the device to be switched off for a predefined period of time then automatically returns to the pre-programmed heating schedule.
Timed heating schedule	Set a heating schedule with up to 6 periods per day.
Heating plus hours	Heat plus hours allows you to extend the current heating period.
Temperature settings	This feature allows you to change your comfort and setback temperatures.
Hot water controls	This feature allows you to control hot water.
Energy data	This feature shows energy used and heat delivered since the beginning of installation.
Date and time	Time and date are set on power up and can be adjusted via the menu.
Advanced settings	Advanced features of the device setup should be set by a competent person.

J. ADVANCED SETTINGS CENTRAL HEATING

Description	Factory setting	New Setting	
		Zone 1	Zone 2
Optimised start Heat pump starts heating in advance of schedule so heating reaches the required temperature at the time specified.	3 hrs		
Optimised stop Heat pump stops heating in advance of schedule so heating reaches the required temperature at the time specified.	OFF		
Display tolerance Select the display tolerance of the room temperature, this can be set at increments of 0.5 or 0.1°C.	0.1°C		
Temperature offset Fine tune the room temperature display -2.5 to 2.5°C.	0°C		
Service phone number Opportunity to input Installer contact number for service reminders.	Ideal Heating number		

Note: Optimised start is default to 3 hours to balance comfort and efficiency for the default temperatures set in Halo.

K. INTERFACE LED KEY

LED	Status
Power	Green - Power ON No illumination - No power
HP Comms	Green - Comms active Green (flashing) - HP Comms reconnecting No illumination - HP Comms fault (check BSB wiring)
Connectivity †	No illumination - Cloud connection not configured Red - No connection Blue - Connection to Wi-Fi network OK, no cloud connection Green - Connection to Wi-Fi and Cloud OK Blue (flashing) - Access point mode
Zigbee	No illumination - No Zigbee network Green - Zigbee network active Green (flashing) - Identify function Red (flashing) - Pairing Red (flashing) then orange - Zigbee network deletion Orange for 30s - Factory reset
Override	Green - Override active* Green (flashing) - Failsafe active* No illumination - Override OFF*

† Only applicable for Halo Air Wi-Fi not Halo Air RF.

*Override and Failsafe only active when communication is lost between the Halo PRT and Smart Interface. See Halo User Guide for more information.



L. ADVANCED SETTINGS HOT WATER - ZONE 1 PRT ONLY

Description	Factory setting	New setting
Timed hot water setting	Disabled	
Emergency immersion heater	Off	

M. CENTRAL HEATING TEMPERATURE SETTINGS

Description	Factory setting	New setting	
		Zone 1	Zone 2
Comfort	21° C		
Setback	18° C		
Frost	8° C		

N. COMMISSIONING CHECKLIST

Description		Confirmed	
		Zone 1	Zone 2
Use the "Identify" function to confirm successful pairing has taken place. Short press on the Pair button on the Air Interface. Press Pair button again to exit "Identify" function.	Zigbee LED on Smart Interface flashes green		
	Halo home screen flashes to indicate successful pairing		
Halo is positioned in the homeowners chosen location if desk mounted.			
Check RSSI (Received Signal Strength Indication) of the Zigbee wireless connection (accessed on the PRT via Menu, Support).	Target RSSI between 0 and -65 and text green		
Check the Smart Interface indication is correct.	Power LED GREEN Zigbee LED GREEN HP Comms LED GREEN		
Full battery level indication on Halo home screen.			
Zigbee network icon is present on the Halo home screen.			
Time and date correct.			
Installer contact details inputted if required (accessed on the PRT via Menu, Advanced Settings, Service phone number).			
Suitable schedule has been entered for the user.			
General overview of operation provided to user - refer to user guide.			
Any advanced settings changes have been recorded.			
Remember to leave this guide with the householder.			

O. TROUBLESHOOTING

No power LED on Smart Interface	Check Smart Interface is securely plugged into the interface bracket. Check power to bracket.
Halo screen shows failed to pair	Check Smart Interface is in pairing mode (Zigbee LED flashing red). Check distance between Smart Interface and Halo (see section B). Reset Smart Interface by inserting a paper-clip or pen tip into reset button. Start pairing mode again on the Smart Interface and press retry on the Halo. If the situation persists then consider using Zigbee Booster (available separately).
Halo screen shows Replace Halo	If you have no other Halo thermostats connected to the Smart Interface or are not replacing an existing Halo then press accept.
In the support page the Zigbee RSSI is lower than -65 and text red	Consider moving the Halo closer to the Air Interface. If the situation persists then consider using Zigbee Booster (available separately).
Deleting Zigbee Network	To delete all devices from the Zigbee network, press and hold the Pair button on the Halo Smart Interface. The Zigbee LED on the Smart Interface will flash red then orange to confirm the devices have been deleted from the network. The PRT should show the welcome screen, if the PRT does not show the welcome screen follow "Deleting Halo from the Zigbee Network" instructions below.
Deleting Halo from the Zigbee Network	On the Halo PRT press the dial and the right hand key together until the welcome screen is displayed. This will delete the Halo PRT from the Zigbee network and factory reset the PRT.
Factory reset of the Smart Interface	Press and hold the Pair button and the Override button for 20 seconds. The Halo Smart Interface will delete all Zigbee devices from the network, this will take approximately 20 seconds and detach from the Wi-Fi network if the control is a connected control. On disconnection, the Smart Interface will automatically begin the setup process as per section D2 of the installation guide. The PRT should show the welcome screen, if the PRT does not show the welcome screen follow "Deleting Halo from the Zigbee Network".



Hereby, Ideal Boilers Ltd declares that this device (model 234791 (RF) & 234792 (Wi-Fi)) is in compliance with: Directive 2014/53/EU.

The full text of the EU declaration of conformity is available at the following internet address idealheating.com

UIN: 235267 A03



RF frequency: 2405 – 2480MHz Max.

RF output power: 10dBm

Ideal Heating is a trading name of Ideal Boilers and associated Group Companies

Ideal Boilers Ltd
National Avenue
Hull, HU5 4JB

T: 01482 498660
E: enquiries@idealheating.com